

**Global engineering –
Trusted solutions**



OWNER'S MANUAL

Single Chamber Blast Machine for 1 Operator

***with manual or pneumatic
media metering valve***

Clemco
International GmbH

Carl-Zeiss-Straße 21
83052 Bruckmühl
Germany

Tel.: +49 (0) 8062 – 90080
Mail: info@clemco.de
Web: www.clemco-international.com

YOUR BLAST MACHINE

| Standard | Pneumatically operated media metering valve | Electric remote controls | Dual function pneumatic | Dual function electric |
|----------|---|--------------------------|-------------------------|------------------------|
| | | | | |

TABLE OF CONTENTS

| | | |
|----------|--|-----------|
| 1 | SCOPE OF MANUAL | 4 |
| 2 | APPLICATION AND RESTRICTIONS..... | 5 |
| 3 | GENERAL DESCRIPTION..... | 5 |
| 3.1 | STANDARD BLAST MACHINE..... | 5 |
| 3.1.1 | How the system works..... | 6 |
| 3.1.2 | How the pneumatic remote control works | 6 |
| 3.2 | BLAST MACHINE WITH PNEUMATICALLY OPERATED MEDIA METERING VALVE..... | 7 |
| 3.3 | OPTIONAL ELECTRIC REMOTE CONTROLS..... | 8 |
| 3.4 | OPTIONAL REMOTE CONTROL WITH DUAL FUNCTION | 8 |
| 3.4.1 | Dual function pneumatic | 9 |
| 3.4.2 | Dual function electro-pneumatic | 10 |
| 3.5 | OPTIONAL SINGLE CHAMBER BLAST MACHINE WITH PNEUMATIC METERING VALVE, COMPRESSED AIR REGULATOR GOVERNED BY PILOT AIR AND RMS REMOTE CONTROL VALVE .. | 10 |
| 3.5.1 | RMS 2000 or RMS 500 + RMS 1500 pneumatic remote control and remote control valves | 10 |
| 3.5.2 | Pneumatic remote control with dual function and RMS 2000 remote control valve..... | 12 |
| 4 | QUICK STOP SYSTEM (ACCESSORIES)..... | 12 |
| 5 | SET-UP AND OPERATION | 14 |
| 5.1 | REQUIREMENTS | 14 |
| 5.2 | SET-UP FOR INITIAL INSTALLATION OR REINSTALLATION | 14 |
| 5.3 | DAILY SET-UP..... | 16 |
| 5.4 | OPERATION | 16 |
| 5.5 | SHUT-DOWN | 17 |
| 5.6 | SHUT-DOWN WHEN MOVING EQUIPMENT | 17 |
| 6 | MAINTENANCE | 17 |
| 6.1 | GENERAL..... | 17 |

| | | |
|----------|----------------------------------|-----------|
| 6.2 | DAILY CHECK LIST | 17 |
| 6.3 | WEEKLY CHECK LIST..... | 17 |
| 6.4 | MONTHLY CHECK LIST..... | 18 |
| 7 | TROUBLE-SHOOTING..... | 18 |
| 8 | REPLACEMENT PARTS | 20 |
| 8.1 | BLAST MACHINES 1440 – 2460..... | 21 |
| 8.2 | BLAST MACHINES MIGHTY MITE | 23 |
| 8.3 | ELECTRIC PANEL RME-1 / -2..... | 23 |

1 Scope of manual

This manual covers operation and maintenance for the following single chamber blast machines with pneumatic or electric remote controls and manually or pneumatically operated media metering valves:

| Volu- mina [l] | Model | Max. pressure [bar] | Remote Control Valve | | Metering valve | |
|---------------------------|--------------|------------------------------------|-------------------------------------|----------------|-----------------------|---------------|
| | | | RMS-2000A (RMS 1500+500) | RMM-50A | pneumat. | Manual |
| 20 | 1028 | 10 | - | ✓ | - | ✓ |
| 40 | 1628 | 10 | - | ✓ | - | ✓ |
| 50 | 1440 | 12 | ✓ | - | ✓ | ✓ |
| 60 | 1638 | 12 | ✓ | - | - | ✓ |
| 100 | 1648 | 12 | ✓ | - | ✓ | ✓ |
| 100 | 2040 | 12 | ✓ | - | ✓ | ✓ |
| 140 | 2048 | 12 | ✓ | - | ✓ | ✓ |
| 200 | 2452 | 12 | ✓ | - | ✓ | ✓ |
| 300 | 2460 | 12 | ✓ | - | ✓ | ✓ |

Table 1: Scope.

FSV, QK-Quantum, MP ½", = manually operated abrasive metering valves

PT = pneumatically operated abrasive metering valve

Additionally the following Owner's manuals should be considered:

- Remote control valve RMS-2000, 1500, 500
- Owner's manual of the metering valve

2 Application and restrictions

Single chamber blast machines can be used with all types of abrasive (60 – degree conical bottom for fine mesh abrasive on option). Table 1 shows the **maximum working pressure** for the different models available. Higher working pressure is possible only for special designs.

The following options are recommended:

- Electric remote controls for very long blast hoses.
- Dual function (pneumatic or electric) to blow-off parts after blasting.

3 General description

3.1 Standard blast machine

The standard blast machine is equipped with **pneumatic remote controls** and a **manually operated media metering valve**.

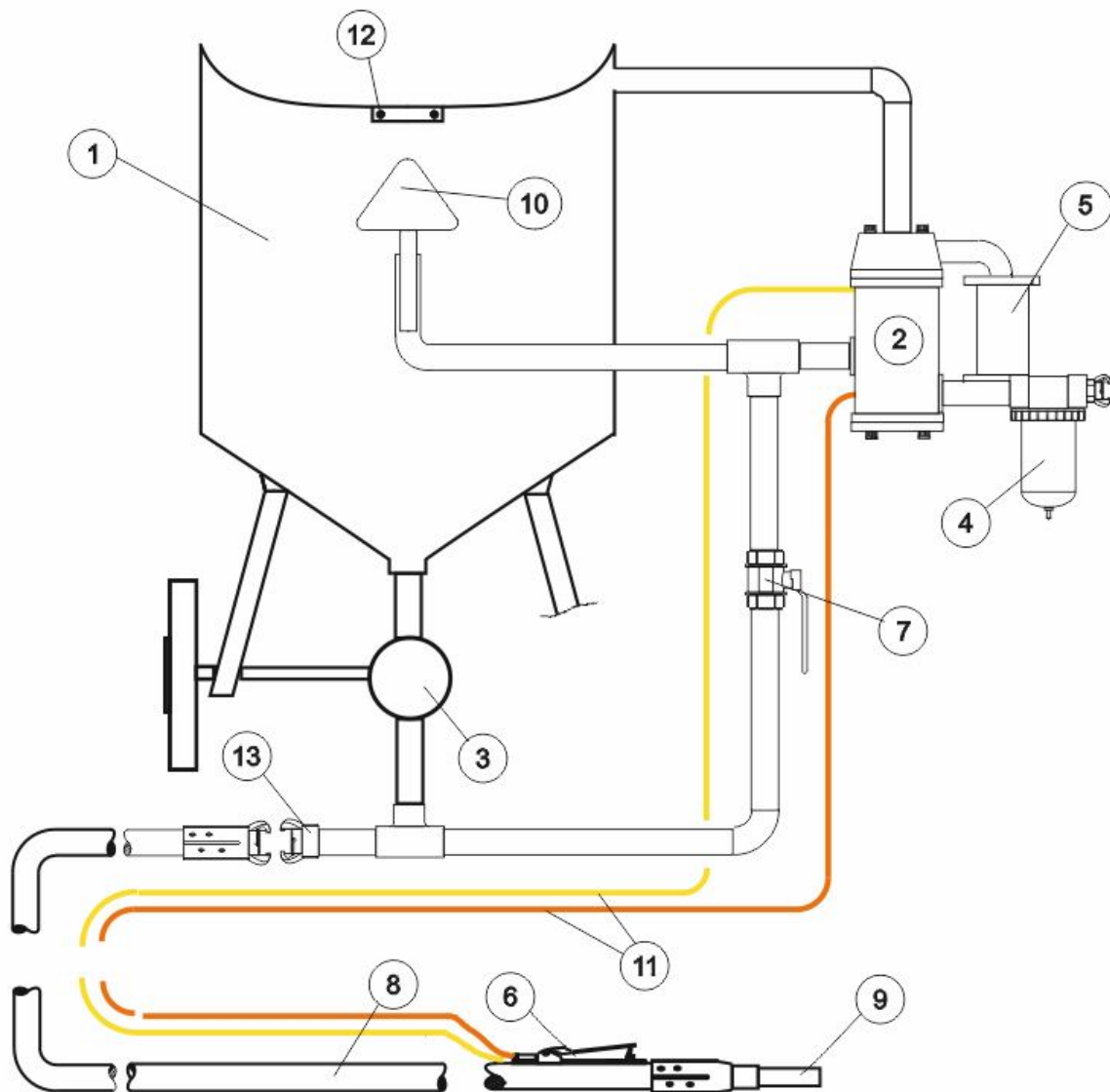

Figure 1: Standard blast machine.

Figure 1 shows the major components of the standard blast machine:

- *Pot with*
 - *remote control valve RMS-2000A (RMS 1500+500) or RMM-50A (item 2).*
 - *muffler (item 5).*
 - *moisture separator (item 4).*
 - *media metering valve (item 3) manually or pneumatically operated.*
 - *choke valve (item 7).*
- *Deadman handle (item 6) with twinline hose (item 11).*
- *Blast hose with nozzle holder and nozzle (item 8 and 9).*

3.1.1 How the system works

When the blast machine is connected to an air supply (compressor), the airflow passes through the moisture separator (item 4) to the remote control valve RMS-2000A or RMM-50A (item 2). When the deadman handle (item 6) is depressed, the pop-up valve (item 10) seals off the filling port with the pop-up gasket (item 12) and the blast pot (item 1) is pressurized. The abrasive metering valve (item 3) controls the flow of abrasive into the air stream.

With the blast hose (item 8) the abrasive is guided to the nozzle (item 9). When the operator releases the deadman handle or the pet cock is opened, the blast process stops and the pot is depressurized.

3.1.2 How the pneumatic remote control works

The remote control enables the operator to start or interrupt blasting from a remote position and is a safety equipment to prevent accidents. **Each blast machine must be equipped with remote control!**

The **pneumatic remote control** consists of a **remote control valve** RMS-2000A or RMM-50A (item 2), a **deadman handle** (item 6) and a **twinline hose** (item 11). The brown remote control hose guides compressed air from the remote control valve to the deadman handle. When the deadman handle is depressed, the air passes from the brown to the yellow hose and is guided back to the remote control valve. The pot is pressurized and the blast process starts. When the deadman handle is released the blast process stops (the pot is depressurized).

For a more detailed description how the remote control valve RMS-2000 (RMS 1500+500) or RMM-50A works, read the included Owner's manual.

3.2 Blast machine with pneumatically operated media metering valve

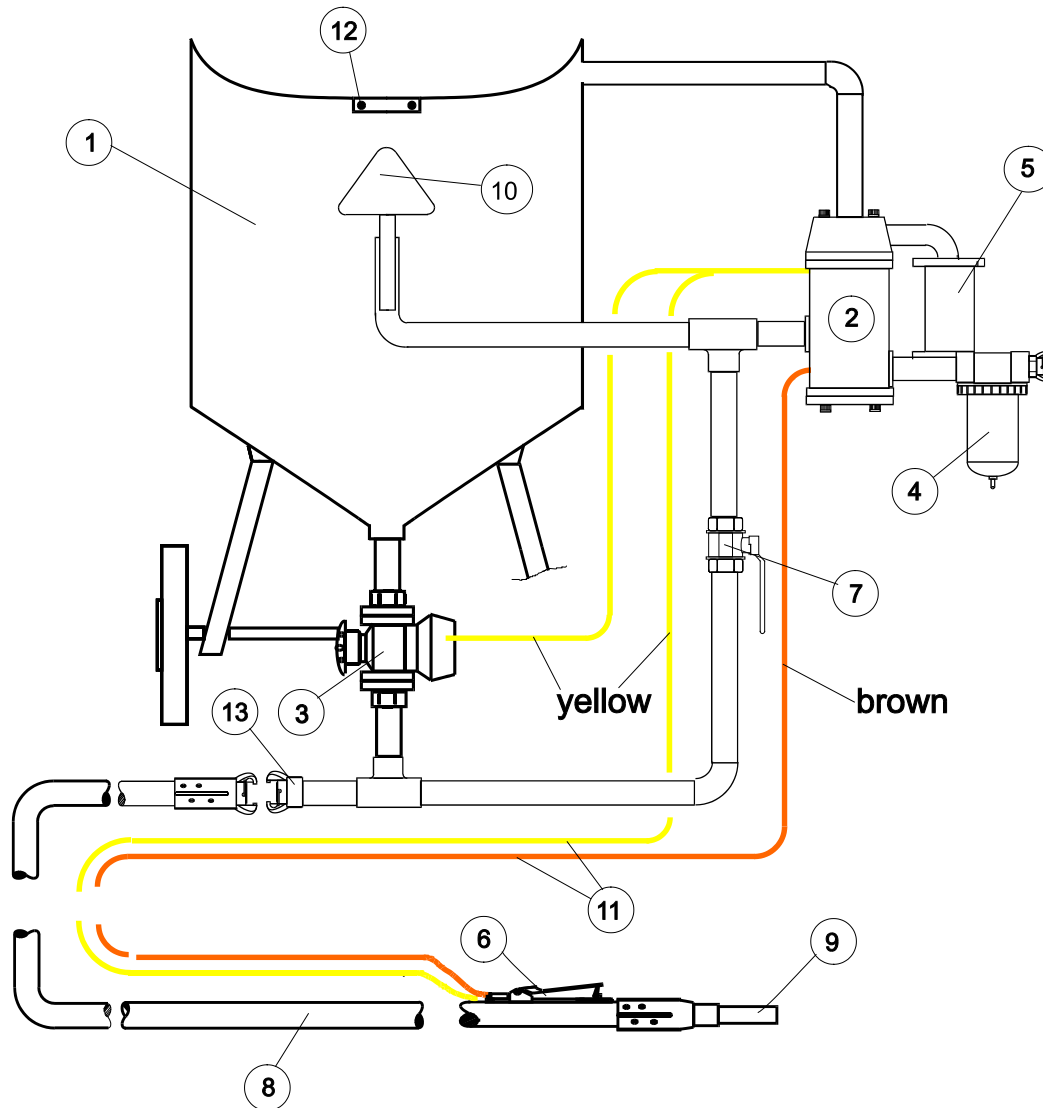

Figure 2: Blast machine with pneumatically operated metering valve and pneumatic remote controls.

Principle of operation: same as the standard pressure blasting device.

When the **deadman handle** (item 6) is **depressed** the **metering valve opens**, when it is released, the **metering valve closes**. Read the Owner's manual for more information on the metering valve.

3.3 Optional electric remote controls

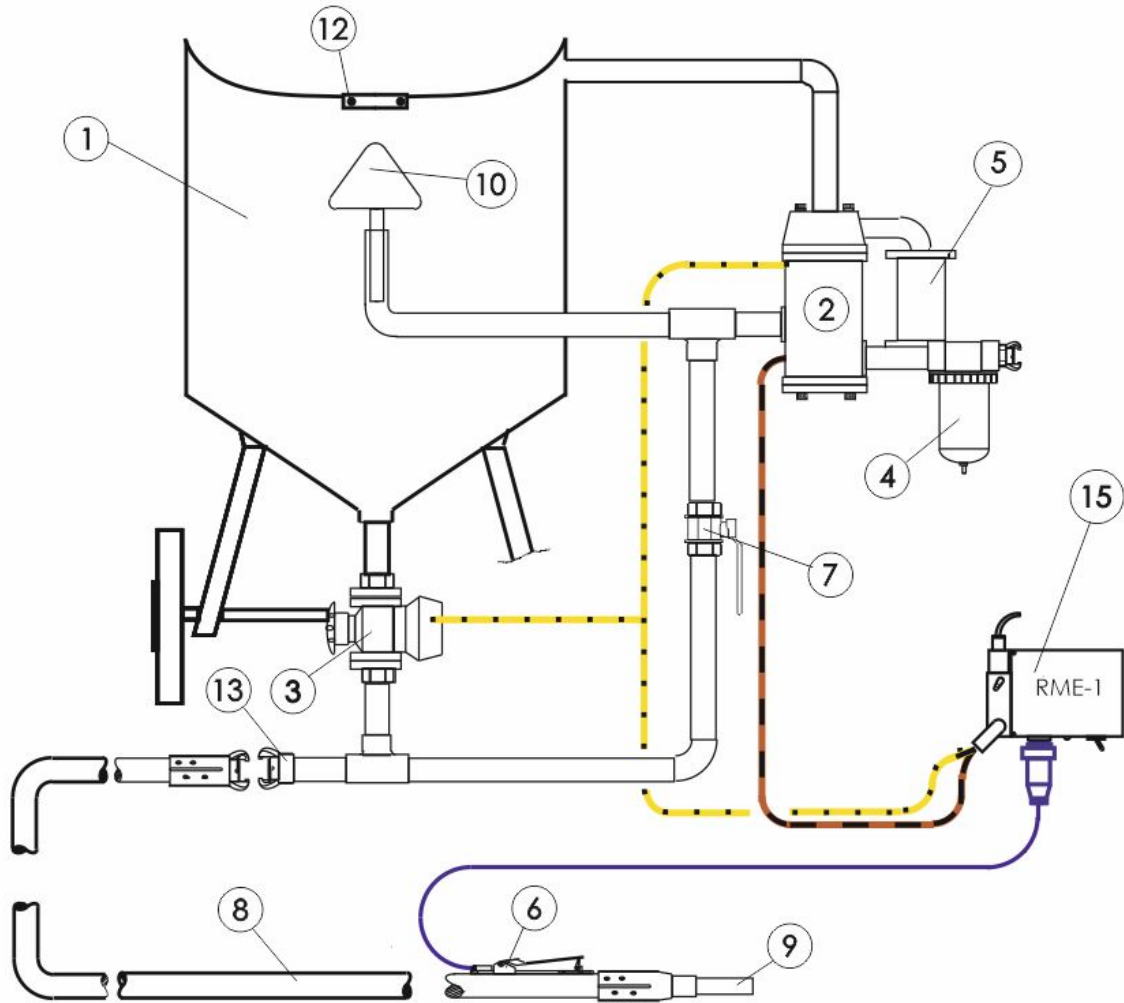

Figure 3: Electric remote controls and pneumatically or manually operated abrasive metering valve.

In order to reduce the time to stop blasting (especially when using longer blast hoses), the **twinline hose** between the deadman handle and the remote control valve is **replaced** by an **electric cord** (orange) and the **electric panel RME-1** (item 15). The magnetic valve converts the electric signal into a pneumatic signal.

3.4 Optional remote control with dual function

This option can only be applied with **pneumatically operated media metering valves** and is especially recommended for very long blast hoses and to blow off the blasted surface with compressed air.

An additional switch on the deadman handle enables the operator to open or close the pneumatically operated media metering valve during blasting (deadman handle depressed).

3.4.2 Dual function electro-pneumatic

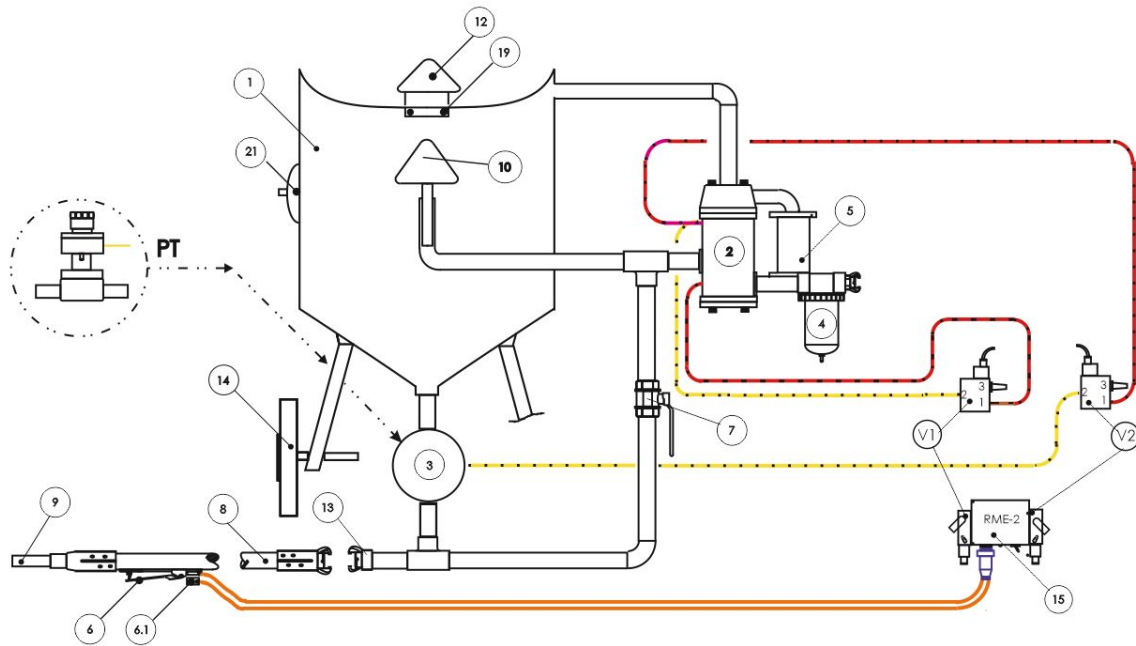

Figure 5: Dual function electric.

An additional electrical switch on the deadman handle enables the operator to open or close the pneumatically operated metering valve when the deadman handle is depressed. A magnetic valve mounted on the electric control panel RME-2 (item 15) converts the electric signal into a pneumatic signal. When the **deadman handle is released the media metering valve closes independent of the switch position.**

3.5 Optional single chamber blast machine with pneumatic metering valve, compressed air regulator governed by pilot air and RMS remote control valve

3.5.1 RMS 2000 or RMS 500 + RMS 1500 pneumatic remote control and remote control valves

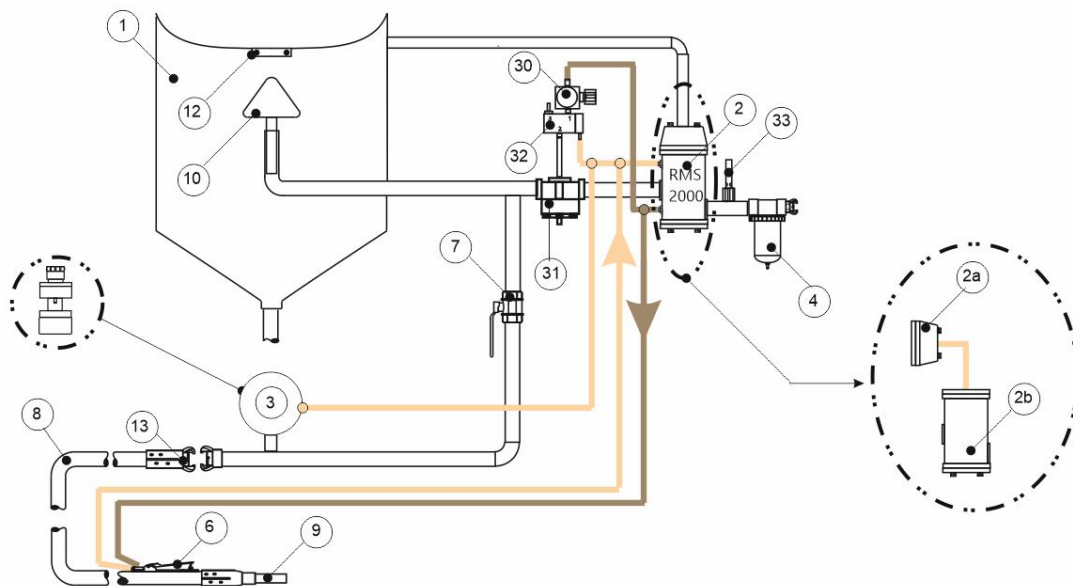

Fig. A

Principle of operation:

Compressed air is supplied to the system via a HMS water separator (item 4). The air is fed into the RMS 2000 remote control valve (item 2) and from there via the port 2A (brown remote control hose)

- to the deadman handle (item 6)
- and to the pressure regulator (1/4" item 30) and the 2/3 way valve (item 32).

When the deadman handle is depressed, the compressed air is fed through the yellow remote control hose

- to the remote control valve port 2B (item 2)
- to the blast media metering valve (item 3) → which opens
- and to the regulator governed by pilot air (item 31).

This causes the blast machine to become pressurised, and the blasting process starts.

The desired blasting pressure can be set at the pressure regulator item 30.

When the deadman handle is released, the air pressure ceases to be supplied via the yellow remote control hose to the remote control valve, so that:

- the RMS 2000 (item 2) is no longer pressurised
- the blast machine is no longer pressurised
- the blast media metering valve (3) closes
- the 3/2 way valve (32) closes

A detailed description of the method of operation of the blast media metering valve used can be found in the metering valve manual supplied.

Options:

- Splitting the RMS 2000 remote control valve into the
 - o RMS 1500 inlet valve
 - o RMS 500 outlet valve
- Additional safety valve (size to be specified by the customer)
- Dual function deadman handle; this allows
 - o the blast media metering valve to be opened and closed whilst the deadman handle is depressed
 - o to blast with air only, for instance when cleaning

3.5.2 Pneumatic remote control with dual function and RMS 2000 remote control valve



Bild - B

Principle of operation:

A slide valve is fitted to the deadman handle (item 6), which allows the operator to open and close the blast media metering valve (blast media feed On/Off) **whilst the deadman handle is depressed** (item 6). When the slide is moved to the **left**, the **metering valve opens**; when it is moved to the **right**, it **closes** again. When the deadman handle is released, the pneumatic metering valve closes, and the blast media feed stops irrespective of the position of the slide valve.

4 Quick Stop System (accessories)

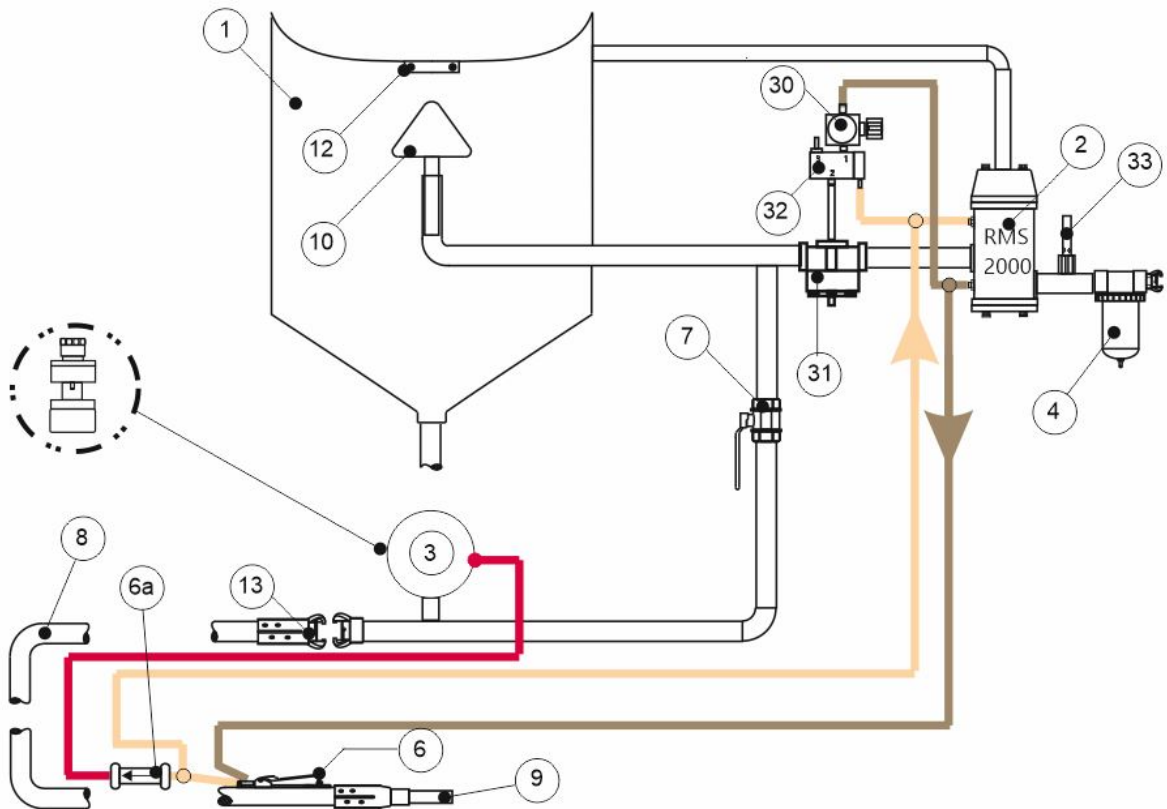
The Quick Stop System SSAS1 is offered in order to reduce the time normally necessary to stop blasting (between 2 and 15 seconds) to **less than 1 second**.

German law demands this equipment.

CLEMCO recommends to use a Quick Stop System for the following applications in other countries:

- Blast pressure ≥ 5 bar
- Length of blast hose ≥ 20 m
- Hard structure abrasive like steel grit

Stock Nr. 90777D

Quick Stop System SSAS1

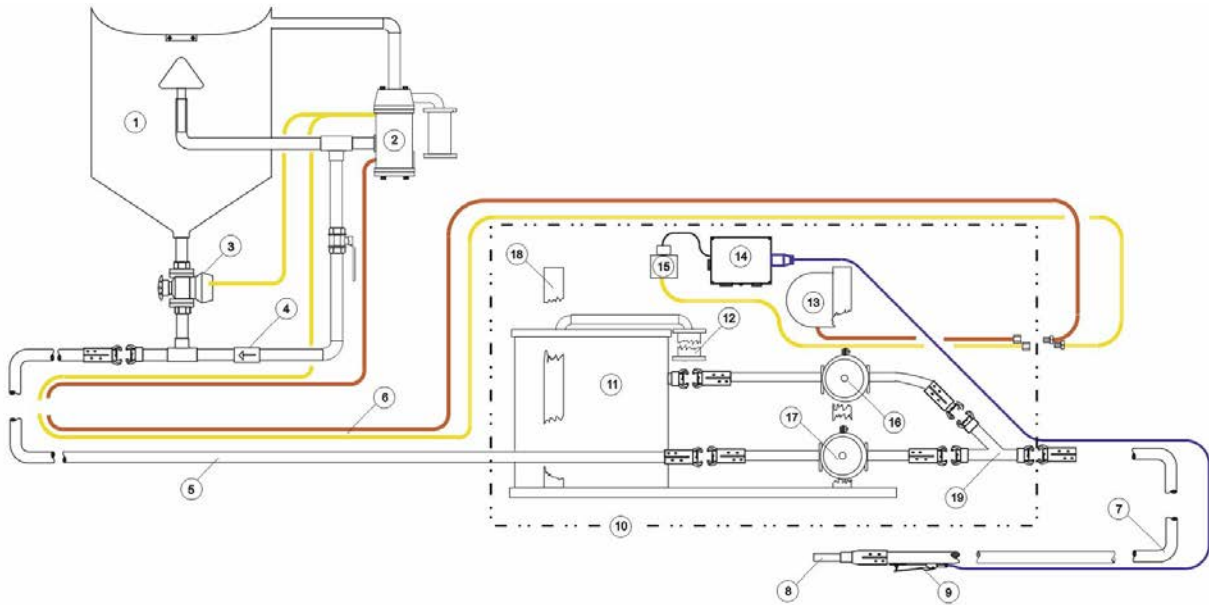

Figure 6: Quick Stop System SSAS1

Legend:

- 1 Blast pot with:
 - 2 Remote Control (example RMS 2000)
 - 3 Abrasive metering valve
 - 4 Non return valve
- 5 Abrasive hose between pot and SSAS1
- 6 Control hose
- 7 Abrasive hose between SSAS and nozzle (max. 10 m)
- 8 Nozzle holder with nozzle
- 9 Electric remote control handle and control cord RLX-E
- 10 Quick stop system SSAS with:
 - 11 Dust container
 - 12 Muffler
 - 13 Air balance buffer
 - 14 Electric control box
 - 15 4/2 way valve
 - 16 Pneumatic valve (closed during blast operation)
 - 17 Pneumatic valve (open during blast operation)
 - 18 Frame

5 Set-up and operation

5.1 Requirements

For a proper function of the blast machine, a sufficient air supply is necessary (see table 2).

| Nozzle size [mm] | Air consumption [$m^3/min.$] | | | |
|------------------|--------------------------------|----------|-----------|-----------|
| | Pressure at the nozzle [bar] | | | |
| | <u>6</u> | <u>8</u> | <u>10</u> | <u>12</u> |
| 6.5 | 2.0 | 2.6 | 3.2 | 4.7 |
| 8 | 3.4 | 4.8 | 5.4 | 6.4 |
| 9.5 | 4.8 | 6.2 | 7.6 | 9.0 |
| 11 | 6.4 | 8.3 | 10.1 | 12.0 |
| 12.5 | 8.4 | 10.7 | 13.1 | 15.4 |

Table 2: Air consumption

5.2 Set-up for initial installation or reinstallation

| | |
|--|--|
| (1) Place blast machine. | On an even and firm ground. |
| (2) Install an air supply for working pressure indicated on pot. | <ul style="list-style-type: none"> – Place compressor upwind near blast machine (no contaminated air should enter compressor). – Start compressor and bring it up to operating temperature (5 to 10min.). Only use compressors whose rating does not exceed the maximum working pressure of the pot! – Attach airline (appropriate dimension) with all necessary gaskets in place to air outlet of compressor and safety lock couplings. Escaping air is dangerous and lowers efficiency! – Carefully open air valve of compressor to blow debris and moisture out of attached airline. – Close air valve. – Install an appropriate coupling to air inlet of blast machine (safety coupling). – Connect airline to blast machine and safety lock it. – For trouble free blasting we recommend an air supply free of oil and water (air cooler with cyclone and automatic drain). |
| (3) Attach blast hose and nozzle to blast machine. | <ul style="list-style-type: none"> – Check gasket of coupling for wear. – Connect blast hoses to length needed (All gaskets must be in place!), attach them to blast machine and safety lock them. – Choose an appropriate nozzle and attach it to nozzle holder (with a gasket). |
| (4) Install a deadman handle and | – Pneumatic remote control: |

| | |
|--|---|
| <p><i>remote control hoses (pneumatic controls) or an electric cord and the electric panel RME (electric remote controls).</i></p> | <ul style="list-style-type: none"> ⇒ Connect twinline hose (yellow/brown) to corresponding twinline hose (yellow/brown) coming from remote control valve RMS-2000A or RMM 50A. ⇒ Connect yellow and brown remote control hose to corresponding yellow and brown nipples of deadman handle. <p>Warning! A reversed connection of remote control hoses causes malfunction and danger of injuries!</p> <ul style="list-style-type: none"> - Electric remote controls: <ul style="list-style-type: none"> ⇒ Connect extension cord to plugs on deadman handle and electric panel RME. ⇒ Connect electric panel RME to remote control hoses coming from remote control valve (corresponding colours of nipple). - With two nylon ties band deadman handle to blast hose just behind nozzle holder. - Every 1,5m band twinline hose or electric cord to blast hose (sufficient freedom of movement, because under pressure blast hose expands). |
| <p><i>(5) Put on protective equipment.</i></p> | <ul style="list-style-type: none"> - Abrasive-resistant clothing. - Airfed helmet with connection to breathing air supply (air filter) and adjustment of air volume with an air control valve attached to belt. - Leather gloves and safety shoes. - Ear protection. |
| <p><i>(6) Check moisture separator, remote control and remove moisture from blast machine.</i></p> | <ul style="list-style-type: none"> - Open petcock on remote control valve RMS-2000A or RMM-50A. - Open choke valve. - Open abrasive metering valve fully. - Open air valve of compressor. - Close petcock on remote control valve RMS 2000A or RMM 50A while depressing deadman handle. - A few minutes hold deadman handle depressed (pop-up valve closes and air comes out of nozzle). - Adjust drain of moisture separator, so that a constant stream of liquid and air is expelled under pressure. - Depressurize blast machine (release deadman handle or open petcock of remote control valve). |

5.3 Daily set-up

Not necessary if an initial installation or reinstallation was performed (see section 5.2).

| | |
|--|---|
| (1) Air supply. | Start compressor and bring it up to operating temperature (5 to 10min.). |
| (2) Put on protective equipment. | <ul style="list-style-type: none"> – Abrasive-resistant clothing. – Airfed helmet with connection to breathing air supply (air filter) and adjustment of air volume with an air control valve attached to belt. – Leather gloves and safety shoes. – Ear protection. |
| (3) Check moisture separator, remote control and remove moisture from blast machine. | <ul style="list-style-type: none"> – Open petcock on remote control valve RMS-2000A or RMM-50A. – Open choke valve. – Open abrasive metering valve fully. – Open air valve of compressor. – Close petcock on remote control valve RMS 2000A or RMM 50A while depressing deadman handle. – A few minutes hold deadman handle depressed (pop-up valve closes and air comes out of nozzle). – Adjust drain of moisture separator, so that a constant stream of liquid and air is expelled under pressure. – Depressurize blast machine (release deadman handle or open petcock of remote control valve). |

5.4 Operation

| | |
|---------------------------------------|---|
| (1) Load abrasive into blast machine. | <ul style="list-style-type: none"> – Close abrasive metering valve. – Open petcock of remote control valve RMS-2000A or RMM-50A. – Pour abrasive into concave head of pot (filling port). |
| (2) Blasting. | <ul style="list-style-type: none"> – Close petcock of remote control valve. – Point nozzle to surface being blasted and depress deadman handle to start blasting. – Adjust choke valve. – Open abrasive metering valve for proper air/abrasive blend. – Blast until pot is nearly emptied of abrasive (do not blast until pot is completely empty because of higher wear). – Proceed with (1). |

5.5 Shut-down

| | |
|-------------------------|---|
| (1) Empty all abrasive. | Blast machine not in use > 1 day (abrasive could get moisture). |
|-------------------------|---|

5.6 Shut-down when moving equipment

No special measures required.

6 Maintenance

6.1 General

During operation blast machines are exposed to wear. In order to ensure safe operation and high efficiency the blast machines should be maintained according to the following check lists.

Prior to maintenance, make sure that the air valve of the compressor is closed and the whole system is depressurized!

6.2 Daily check list

| | |
|---|---|
| (1) Pot. | <ul style="list-style-type: none"> – Check gasket of filling port and replace it at first sign of wear (replacement possible from outside). – Check pop-up valve and replace it at first sign of wear. |
| (2) Airline and blast hose. | <p>Check hoses for sharp bends, causing high loss of energy and rapid wear.</p> <p>No vehicles should pass over hoses!</p> |
| (3) Nozzle and nozzle holder. | <ul style="list-style-type: none"> – Check nozzle gasket and replace it at first sign of wear. – Check nozzle and nozzle holder (thread) for wear and replace them if necessary. |
| (4) Remote control valve and accessories. | <ul style="list-style-type: none"> – Open petcock of remote control valve RMS 2000A or RMM 50A and check for water. If water is detected check moisture separator (see section 5.3) – Check rubber button of deadman handle for wear and replace it if necessary. – Check fittings of remote control valve for tightness. – Check all electric and pneumatic connections of electric panel RME-1 or RME-2 (electric remote controls). |

6.3 Weekly check list

| | |
|--------------------------------|--|
| (1) Moisture separator. | <p>Remove and check filter element. If necessary clean filter and sight glass with soap and warm water and dry it with compressed air.</p> <p>A dirty filter causes loss of pressure in the system!</p> |
| (2) Muffler. | Check for wear or blockage and clean or replace interior body. |
| (3) Air hoses and blast hoses. | <ul style="list-style-type: none"> – Check all couplings and screws for wear or breakage and replace them if necessary. – Check whole blast hose by hand for soft spots (reduced wall thickness) and replace it immediately when soft spots are |

| | |
|--|---|
| | <p>detected.</p> <ul style="list-style-type: none"> – Check airline (air supply) and replace it when it is worn. – Check gaskets of couplings for wear and replace them if necessary. |
|--|---|

6.4 Monthly check list

| | |
|---|---|
| (1) Remote control valve RMS-2000A (RMS 1500+500) or RMM-50A. | Check all fittings and connections of remote control valve for leakage. |
| (2) Muffler. | Check condition of muffler and corresponding piping. |

7 Trouble-shooting

| Problem | Probable cause | Remedy |
|---|--|---|
| (1) Neither abrasive nor air comes out of nozzle. | Air valve of compressor is closed. | Open air valve. |
| | Blocked moisture separator. | Check and clean moisture separator. |
| | Remote control valve RMS-2000A (RMS 1500+500) or RMM-50A (item 2) doesn't work. | Check remote control valve and remote control hoses for loose connections while outlet valve is closed (depressed deadman handle). |
| | Electric remote controls: magnetic valve of electric panel RME (item 15) is blocked. | Disassemble and clean it. |
| (2) Air but no abrasive comes out of nozzle. | Closed abrasive metering valve. | Open abrasive metering valve. |
| | <ul style="list-style-type: none"> – Moist abrasive blocks abrasive flow at bottom of pot. – No screen or cover. | <ul style="list-style-type: none"> – Several times open and close choke valve (item 7) rapidly. Attention! This measure leads to increased wear of the rubber nipple in the abrasive metering valve FSV (service life <50h) – Open inspection door and clean pot. – Install an after cooler for air supply. |
| (3) Irregular flow of abrasive comes out of nozzle. | Incorrectly adjusted abrasive metering valve (item 3). | Check adjustment and open it completely if necessary. |
| | Clogging. | <ul style="list-style-type: none"> – Check nozzle and gasket for wear and replace them if necessary. – Open inspection plate of metering valve and clean it. |
| | Choke valve incorrectly adjusted. | Correctly adjust choke valve. |

| | | |
|--|---|---|
| (4) <i>Too much abrasive comes out of nozzle.</i> | Abrasive metering valve too much opened. | Check and correct adjustments. |
| | Choke valve not completely opened. | Check and open it completely if necessary. |
| (5) <i>Pop-up valve does not remain closed.</i> | Insufficient air volume or pressure. | Check air pressure of compressor with a needle gauge. |
| (6) <i>Pop-up valve does not seal off filling port after pressurization.</i> | Worn pop-up valve and / or gasket (item 10). | Replace pop-up valve and / or gasket. |
| | Blocked guide for pop-up valve. | Open inspection door (item 21) and clean blast machine. |
| (7) <i>Blast machine does not depressurize or is blocked.</i> | Clogged deadman handle. | Clean deadman handle. |
| | Remote control hose incorrectly connected. | Exchange connections. |
| | Remote control valve RMS-2000A (RMS 1500+500) or RMM-50A defective. | Disassemble and repair it. |
| | Electric remote controls (with or without dual function): Switch on the magnetic valve in position "1" (manual control). | Put switch in position "0" (automatic control). |

8 Replacement parts

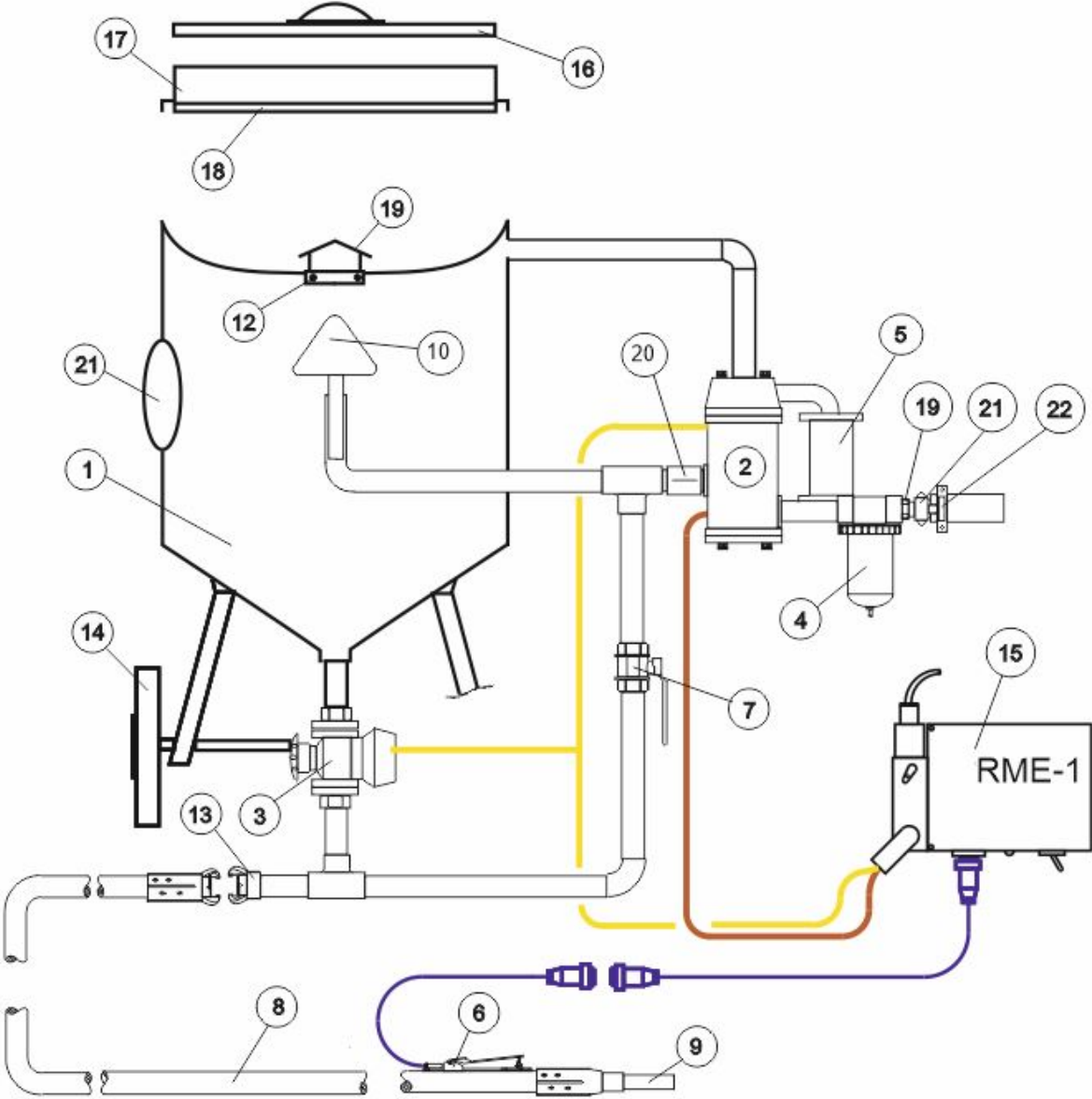

Figure 7: Replacement parts.

8.1 Blast Machines 1440 – 2460

| Pos. | Part no. | Description | Model | | | | | |
|--------|----------|---|-------|------|------|------|------|------|
| | | | 1440 | 1638 | 2040 | 2048 | 2452 | 2460 |
| (-) | 90550D | P-8-R Y-piece 1 ¼" rubbered | ✓ | ✓ | ✓ | ✓ | ✓ | ✓ |
| (-) | 90552D | Hex nipple P32 1 ¼"rubbered | ✓ | ✓ | ✓ | ✓ | ✓ | ✓ |
| (-) | 90551D | Nipple P31 1 ¼" x100 rubbered | ✓ | ✓ | ✓ | ✓ | ✓ | ✓ |
| (-) | 02329D | Gasket for inspection door | ✓ | ✓ | ✓ | ✓ | ✓ | ✓ |
| (-) | 90670D | Safety lock ring for wheel 2452, 2460 | - | - | - | - | ✓ | ✓ |
| (-) | 90671D | Safety lock ring for wheel 1028, 1648, 2040, 2048 | - | ✓ | ✓ | ✓ | - | - |
| (-) | 90276D | T-piece with flange 1 ¼" | ✓ | ✓ | ✓ | ✓ | ✓ | ✓ |
| (-) | 90050D | Fitting kit for RMS-2000A | ✓ | ✓ | ✓ | ✓ | ✓ | ✓ |
| (2) | 100012 | Remote control RMS-2000A with silencer | ✓ | ✓ | ✓ | ✓ | ✓ | ✓ |
| option | 100028 | RMS 1500 Inlet valve Assy | | | | | | |
| option | 100030 | RMS 500 Exhaust valve Assy | | | | | | |
| (3) | 02427D | Valve FSV 1 ¼" | ✓ | ✓ | ✓ | ✓ | ✓ | ✓ |
| | 22780D | QK- Quantum K Ventil | ✓ | ✓ | ✓ | ✓ | ✓ | ✓ |
| | 90378D | PT-Valve 1 ¼" TC | ✓ | ✓ | ✓ | ✓ | ✓ | ✓ |
| (4) | 90545D | Water separator 1 ½" HMS | ✓ | ✓ | ✓ | ✓ | ✓ | ✓ |
| (5) | 90743D | Silencer RMS 2000 | ✓ | ✓ | ✓ | ✓ | ✓ | ✓ |
| (6) | 100707 | RLX III Deadman handle | ✓ | ✓ | ✓ | ✓ | ✓ | ✓ |
| | 05801D | RLX-E Electric deadman handle | | | | | | |
| (7) | 02397D | Ball valve 1 ¼" | ✓ | ✓ | ✓ | ✓ | ✓ | ✓ |
| (8) | | Blast hose (different sizes) | ✓ | ✓ | ✓ | ✓ | ✓ | ✓ |
| (9) | | Nozzle and nozzle holder (different sizes) | ✓ | ✓ | ✓ | ✓ | ✓ | ✓ |
| (10) | 02321D | Pop-up valve P-2 with shaft ½" | ✓ | ✓ | ✓ | ✓ | ✓ | ✓ |
| (12) | 99157D | O-Ring P-5 with quarterlip | ✓ | ✓ | ✓ | ✓ | ✓ | ✓ |
| (13) | 91011D | CFT cast iron coupling 1 ¼" | ✓ | ✓ | ✓ | ✓ | ✓ | ✓ |
| | 24232D | CFT cast iron coupling 1 ½" (for PT valve) | ✓ | ✓ | ✓ | ✓ | ✓ | ✓ |
| (14) | 90566D | Wheel for 1028, 1628 | ✓ | - | - | - | - | - |
| | 90567D | Wheel for 1638, 1440, 2040, 2048 | - | ✓ | ✓ | ✓ | - | - |
| | 02350D | Wheel for 2452, 2460 | - | - | - | - | ✓ | ✓ |
| (15) | 90890D | RME-230 / 12V E-Schaltkasten | ✓ | ✓ | ✓ | ✓ | ✓ | ✓ |
| (16) | 02334D | Cover für 1440 | ✓ | - | - | - | - | - |
| | 02335D | Cover für 1628, 1638, 1648 | - | ✓ | - | - | - | - |
| | 02336D | Cover für 2452, 2460 | - | - | - | - | ✓ | ✓ |
| | 90562D | Cover für 2040, 2048 | - | - | ✓ | ✓ | - | - |
| | 02330D | Screen for 1440 | ✓ | - | - | - | - | - |

| | | | | | | | | |
|----------------|----------|--|---|---|---|---|---|---|
| (18) | 02331D | Screen for 1628, 1638, 1648 | - | ✓ | - | - | - | - |
| | 02332D | Screen for 2452, 2460 | - | - | - | - | ✓ | ✓ |
| | 90561D | Screen for 2040, 2048 | - | - | ✓ | ✓ | - | - |
| | 90661D | Screen insert for 1440 | ✓ | - | - | - | - | - |
| | 90662D | Screen insert for 1628 | - | ✓ | - | - | - | - |
| | 90663D | Screen insert for 2040, 2048 | - | - | ✓ | ✓ | - | - |
| | 90664D | Screen insert for 2452, 2460 | - | - | - | - | ✓ | ✓ |
| (19) | 02339D | Umbrella for blast machine | ✓ | ✓ | ✓ | ✓ | ✓ | ✓ |
| | 90024D | Nipple 1 ½" N46 OS | ✓ | ✓ | ✓ | ✓ | ✓ | ✓ |
| (20) | 99633D | Non return valve 1 ¼" | ✓ | ✓ | ✓ | ✓ | ✓ | ✓ |
| (21) | 90038D | Screwing LW32 46/32 | ✓ | ✓ | ✓ | ✓ | ✓ | ✓ |
| (22) | 99641D | Clamp SK 51 | ✓ | ✓ | ✓ | ✓ | ✓ | ✓ |
| (30) option | 100061 | Pressure regulator ¼" with manometer | ✓ | ✓ | ✓ | ✓ | ✓ | ✓ |
| (31) option | 10711Z | Pressure pilot valve 1 ½" | ✓ | ✓ | ✓ | ✓ | ✓ | ✓ |
| (32) option | 93126A | Magnetic valve ¼" | ✓ | ✓ | ✓ | ✓ | ✓ | ✓ |
| Option | 99698D | Coil magnetic valve 24VDC | ✓ | ✓ | ✓ | ✓ | ✓ | ✓ |
| (33) option | 90023D | Safety valve 1" 12bar | ✓ | ✓ | ✓ | ✓ | ✓ | ✓ |
| (34) | 02323D | Inspection door Assy | ✓ | ✓ | ✓ | ✓ | ✓ | ✓ |
| option | JH110006 | Blast pot for single chamber blast room SC2452 F | | | | | ✓ | |
| Option | JH110005 | Pilot set (includes among others 30 + 32) | | | | | ✓ | |

The non-return valve (item 20) is recommended for:

- Combined use of blast machine and suction unit.
- Operation with silo.
- Compressors without non return valve.
- Air supply with several users.

8.2 Blast Machines Mighty Mite

| No. | Stock No. | Description | Model | |
|------|-----------|---|-------|------|
| | | | 1028 | 1628 |
| (-) | 99093D | Safety ring for wheel 1028 | ✓ | - |
| (-) | 90002D | KAG-12 Air coupling 1/2" | ✓ | ✓ |
| (-) | 93050D | Fitting kit for RMM-50A / 1028 | ✓ | ✓ |
| (2) | 90211D | RMM 50A, Remote control with silencer and RLX-III | ✓ | ✓ |
| (3) | 24376D | MP-1/2" Steel grit valve | ✓ | ✓ |
| (4) | 90256D | Water separator 1/2" MM-HMS | ✓ | ✓ |
| (4) | 90920D | Water separator 1/2" with automatic drain | ✓ | ✓ |
| (10) | 01242D | Pop up valve MP-2 with shaft 1/4" | ✓ | ✓ |
| (12) | 01245D | O-Ring MP-5 | ✓ | ✓ |
| (12) | 90251D | Gasket for O-ring 1028, 1628 | ✓ | ✓ |
| (13) | 90257D | CFB-0 Coupling 1/2" | ✓ | ✓ |
| (13) | 90259D | CQG-0 Gasket for CQB-0, CFB-0 | ✓ | ✓ |
| (14) | 90566D | Wheel for 1028, 1628 | - | ✓ |
| (16) | 90254D | Cover for 1028 | ✓ | - |
| (16) | 02335D | Cover for 1628, 1638, 1648 | - | ✓ |
| (17) | 03362D | Screen for 1028 | ✓ | - |
| (17) | 02331D | Screen for 1628, 1638 | - | ✓ |

8.3 Electric panel RME-1 / -2

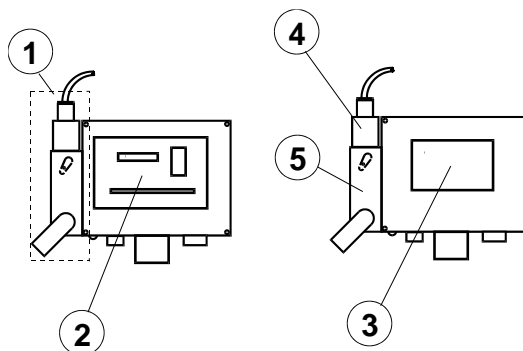

Figure 8: Electric panel RME-1

| No. | Stock No. | Description |
|------------|------------------|--|
| (-) | 90640D | RME electric panel 230V power supply with deadman handle RLX-E |
| (-) | 90887D | RME-1 electric panel 230/12V with deadman handle RLX-E |
| (-) | 90890D | RME-230/12V electric panel |
| (-) | 90888D | RME-2 electric panel with RLX-E for dual function |
| (-) | 90891D | RME-2A electric panel for dual function without deadman handle |
| (1) | 93126D | ¼" - 12V solenoid valve for RME-230/12 |
| (2) | 99634D | Board for RME-230/12V |
| (3) | 90124D | Transformer for RME-230/12V |
| (4) | 99699D | Coil 12V DC |
| | 99697D | Coil 230V DC |
| (5) | 93126A | Valve ¼" without coil with plug |
| (-) | 100073 | Upper part for magnet 12V |